



# 500 XLE

TREATMENT CHAIR



E

2023Y03

ENJOY QUALITY AND DESIGN

# 500 XLE

Item No.: 1500 0006

The perfect reclining treatment chair for rotation systems in outpatient operating rooms.

**Powerful  
and agile**



## MED.TEC at its highest level

### Double castors

Four fully rotating double-run castors for back-friendly, easy rolling motion.



### Chassis/frame

Precision steel frame chassis, zinc primed with anthracite textured paint coating.

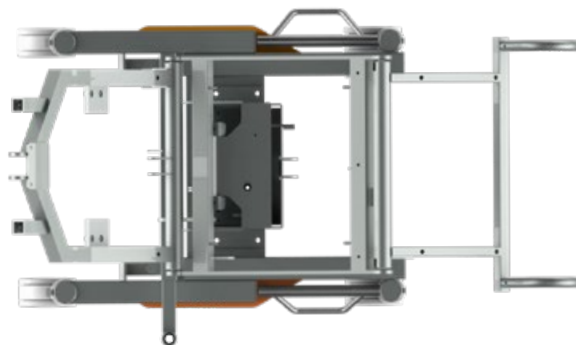

### Chassis cover/upholstery

The mirror-finish plastic cover panels with their scratch-resistant and impact-modified surface finish are extremely hygienic and easy to disinfect.

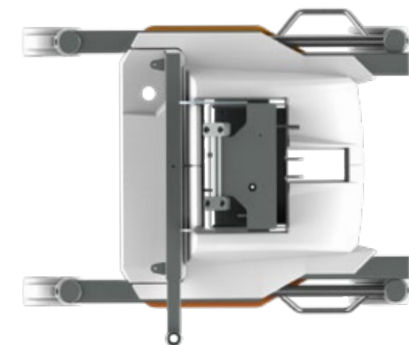

## Precise positioning of the head part

### Headrest

3D and longitudinally adjustable headrest element with head molding and neck support for guaranteed safe and correct head positioning.

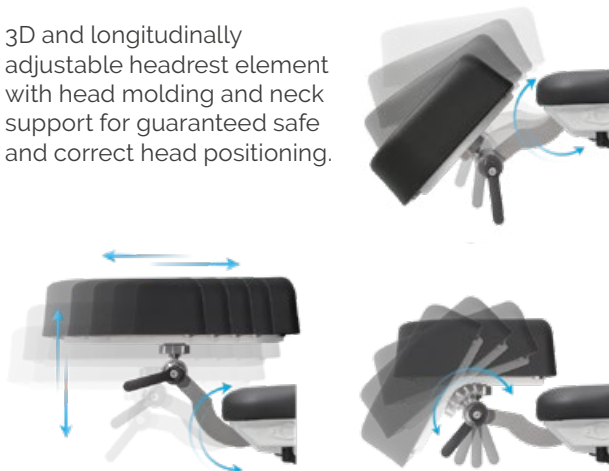

## Components

### Headrest with ball joint and more

Discover additional features and extensive components on page 34-35.

Item No.: 3351 1021



## Sterile adjustment by surgeon/maximum legroom



### Flexible reaction by foot control

Removable foot keypad for infinite electronic height and head adjustment including reactivation button from the stand-by mode.





# Positioning



The 500 **XLE** treatment chair is designed for ergonomic and comfortable patient positioning and treatment, particularly for outpatient surgical techniques. It offers versatile adjustment of the head, back, seat and leg sections and overall chair height for patient transport.

- Eight freely programmable memory positions
- CPR button
- Reset button
- Auto run function
- Battery charge indicator



## Hand control

### Multi-functional manual keypad

 Battery charge indicator

 Reset button

 CPR button

 AUTO Auto run function

 MEMORY 8 free configurable memory positions

## Positioning by hand control

### Standard recommended memo keys



## Mechanical maneuvering aid on the chassis



### Operation via foot lever on the chassis

Activation of directional guidance

Pushing from the head direction



Pushing from the foot direction

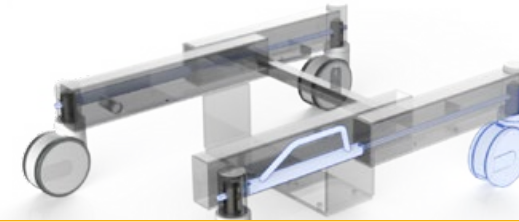

## Braking system

### Manually adjustable foot lever

Castors are braked

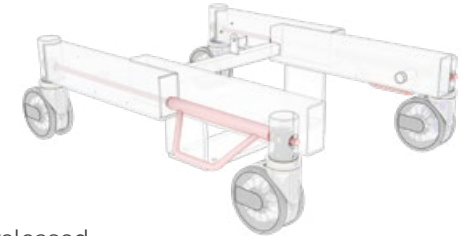

Castors are released, directional guidance is deactivated

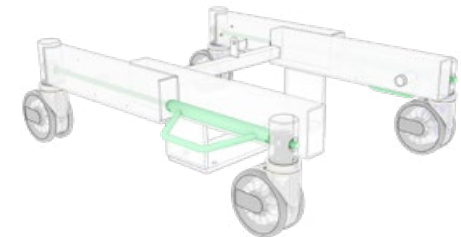

## Push handles

Detachable push handles on the foot ends for easy maneuvering.



## Armrests

Hinged and removeable armrests for easy entry and exit as well as transfer of the patient.



## Components

### Additional handles/shoulder parts and more

Discover additional features and extensive components on page 34-35.



# 500 XLE comfort

Item No.: 1500 0006  
+ 3037 0080

Our 500 XLE with extra thick upholstery, integrated knee support cushion and flattened neck area - for extra reclining comfort.

**Outstanding comfort,  
particular flexibility.**



## Upholstery

### Comfort

Thick comfort upholstery and integrated knee support cushion, individually positionable to suit every patient's body height. The treatment chair featuring comfort upholstery is particularly well suited for longer surgical procedures (e.g. retina surgery).



Available in a wide variety of colors. Please refer to page 100 for our complete range of colors.



## Flexibility in every detail

### Headrest

The flattened back cushion of the Comfort upholstery in the neck area offers maximum freedom of movement for the headrest.



### Integrated knee support cushion

Optimum patient comfort thanks to the integrated knee support cushion which can be easily adjusted to accommodate any patient height.



An optional legrest extension can be attached when treating tall or very tall patients.



## Components

### Foot part extension

Adjustable foot part extension incl. foot support for easier entry and exit of the patient.



Besides, entry height is reduced by 80 mm.

Item No.: 3351 1028



190 mm

# Technical specifications



## Chassis

- Frame profile 90 x 50 mm
- Outside length 785 mm
- Outside width incl. lever 720 mm
- Steel tube frame, powder-coated elegant anthracite matte finish
- Brake operable from both sides and acting on two castors each; two castors featuring independent directional steering function
- Double rimmed castors  $\varnothing$  125 mm
- Detachable foot keypad (total, head up/down)
- Emergency stop button
- Visible screws are made of stainless steel
- With equipotential bonding connection

## Trendelenburg/Reverse Trendelenburg/CPR



## Upper frame

- 4-part support frame (head, back, seat, leg part)
  - Removeable upholstery
  - Width of upholstery 610 mm
  - Width incl. armrests 850 mm
  - Length 1.760 – 1.900 mm  
(incl. legrest extension) + 190 mm
- |                     | Angle                      | Dimensions (L x W)  |
|---------------------|----------------------------|---|
| • Head part         | -29°/+35°                  | 255 x 245 mm  |
| • Back part         | 0°/+83°                    | 610 x 610 mm  |
| • Seat part         | -5°/+35°                   | 450 x 610 mm  |
| • Leg part          | 0°/-77°                    | 510 x 610 mm  |
| • Height adjustment |                            | 625 – 925 mm<br>(comfort) 655 – 955 mm  |
| • Armrests          | 0°/+180°                   | (2x) 470 x 75 mm  |
| • Entry height      |                            | (standard) 580 mm/500 mm (incl. legrest extension)<br>(comfort) 610 mm/530 mm (incl. legrest extension) |
| • Legroom           |                            | 520 – 820 mm  |
| • Trendelenburg     | -12°/Reverse Trendelenburg | +5°   |

## Back part/leg part



## Electrical control

- All components according to IP54
- Hand control with 8 individually programmable memory positions, auto run function, reset button
- Foot keypad with 4 foot switches and reactivation button

## Electric Drives

- Head, back, seat, leg part, total up/down
- Trendelenburg/Reverse Trendelenburg

## Lifting column

- Max. lifting 300 mm
- Max. load 250 kg
- Motors IP54 with HAL sensors, to be memorized

## Height adjustment





## Powerful accumulators

- Battery box with 2 batteries (lead-gel), pollution free, maintenance-free, cadmium-free 2 x 12 V, 7,2 Ah
- As back-up-system exchangeable without tools
- Acoustic low voltage signal for discharge protection
- Universal battery charger Input: 100 – 240 V Output: 30 V

### Operating time per battery charge

- Measured by operating circle (Prepare-Operate-Recover) 100 OPs
- Quantity of operating circles depends on individual operation

## Further technical details

- Chair has detachable, swiveling armrests made completely with PUR foam
- Detachable seat for service friendly access to electric components

Max. load 250 kg

Weight 135 kg

Subject to technical modifications.

## Mains-free operation

Easy recharging of the equipment thanks to charging adapter and integrated battery charger circuit board.



## Simple battery replacement

Additional safety due to replaceable battery box (back-up system **Item No.:** 3047 0000). Discharged battery box can be replaced quickly.



## Equipment protection

### Cover drape *stayClean*

2,000 x 730 mm, box á 160 Pieces  
4 x 40 Pieces

**Item No.:** 3034 0014

Page 64



## Upholstery/color card

### Standard color

**500 XL**

anthracite **Item No.:** 3037 0052

**500 XLE comfort**

anthracite (main color)  
+ chrome (accent color)  
**Item No.:** 3037 0092

"skai Tundra"

Page 102

"skai Pandoria Plus"

Page 103



# Components



## 500 XLE

Item No.: 1500 0006



## 500 XLE comfort

Comfort upholstery incl. integrated knee roll, upcharge

Item No.: 1500 0006 + 3037 0080



Side parts right and left, swiveling incl. locking, upholstered, 580x200 mm

Item No.: 3351 0012



Norm rail seat part

Item No.: 3351 0047



Side parts right and left, 580x200 mm, incl. quick-release clamp for mounting on norm rail (norm rail 3351 0047 not included)

Item No.: 3351 0050



Backup battery

Item No.: 3047 0000



Pushing handles back part, pair

Item No.: 3351 0046



Pushing handles back part, pair

Item No.: 3351 0017



Anesthesia arm board with universal joint, with arm secure straps

Item No.: 3351 0011



Flexible surgical drape support rod

Item No.: 3205 0000



Flexible surgical drape support rod with air connection

Item No.: 3206 0000



Hand control holder, PVC (component holder 3351 0037 not included)

Item No.: 3351 1023



Headrest with ball joint, 360° all-round adjustment, factory-fitted

Item No.: 3351 1021



Hand control holder for attachment onto an I.V. Pole Ø 25/18 mm, PVC

Item No.: 3351 1022



Head part bumper stainless steel

Item No.: 3028 0000

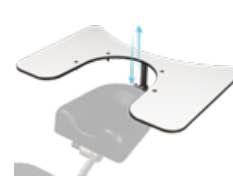

Wrist rest 550x370 mm, height adjustable, incl. mounting plate, adjustment 115 mm

Item No.: 3209 0000

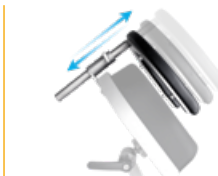

Wrist rest, adjustable, incl. mounting plate 3013 0000, adjustment 115 mm

Item No.: 3014 0000

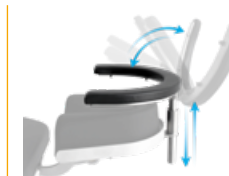

Wrist rest, adjustable, tiltable, incl. mounting plate 3013 0000, adjustment 115 mm

Item No.: 3014 0005



Mounting plate stainless steel, for wrist rest 3014 0000, 3014 0005 and 3209 0000

Item No.: 3013 0000

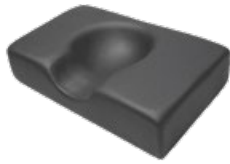

Head fixation pillow with hollow (rubins pillow), 410x250 mm, height 100 mm, factory-fitted

Item No.: 3022 0000

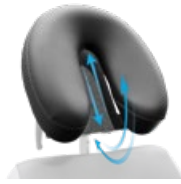

Facial pillow, horseshoe-shaped, incl. adapter plate, factory-fitted

Item No.: 3351 1016

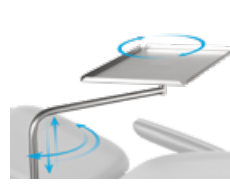

Instrument table 500x300x15 mm, height adjustable, swiveling, detachable, incl. adapter (component holder 3351 0037 not included)

Item No.: 3065 0000



Shoulder parts right and left **500 XLE**  
Item No.: 3071 0000

**500 XLE comfort**  
Item No.: 3071 0001

## Hygiene product



Cover drape for treatment chair, **stayClean** 2,000x730 mm, box à 160 pieces

Item No.: 3034 0014



Knee half roll, 600x280x140 mm, PUD-coated

Item No.: 3019 0000



Knee roll round, 500x150 mm, PUD-coated

Item No.: 3050 0000



Wrist secure straps, pair

Item No.: 3015 0000



Body strap with Velcro straps, 2-piece

Item No.: 3083 0000



Foot part extension incl. foot support, factory-fitted, upcharge

Item No.: 3351 1028



Foot protection foil

Item No.: 3092 0001



IV. Pole stainless steel Ø 25/18 mm, one-hand height adjustable 1,070 – 1,660 mm, 4 hooks, max. 2 kg/hook, glass and holder (component holder 3351 0037 not included)

Item No.: 3068 0000



Component arm stainless steel, swiveling, incl. extendible IV. Pole Ø 25 mm

Item No.: 3024 0014



Component holder, stainless steel

Item No.: 3351 0037



Cylinder holder

Item No.: 3072 0002

## Medical products



Instrument table **supportLine** height adjustable 730 – 1,000 mm

Item No.: 3351 0026



Instrument table **supportLine plus** height adjustable 930 – 1,200 mm

Item No.: 3351 0045

# “skai® Tundra”



High quality skai® material with fine calf leather grain and subdued matte-gloss-effect. The very extensive and trend-orientated color spectrum enables many applications and combinations.

### Product Specification

- Long-lasting
- Tear resistant
- Easy to clean
- Abrasion resistant (DIN EN ISO 6570-2)
- Lightfast
- Disinfectant resistant
- Biocompatibility: cytotoxicity (EN ISO 10 993-5) and epicutaneous test (EN ISO 10 993-10)
- Blood- and urine resistant
- Phthalate-free
- Vegan

<i>eyeForce</i>		1800 0000
<i>500 XLE</i>		1500 0006
<i>500 XLE comfort</i>		1500 0006
		+ 3037 0080
<i>500 XLS</i>		1500 0005
<i>500 ECO</i>		1500 0008
<i>400 XL</i>		1400 0001
<i>surgiForce</i>	Formed seat	2600 0008
<i>surgiForce light</i>	Formed seat	2600 0009
<i>surgiLine</i>	Formed seat	2200 0008
<i>assistLine</i>		2400 0015
<i>motionLine</i>		1700 0000
<i>motionLine-E</i>		1700 0001

+ Item No.: 3037 0...

weiß F6461198 Item No.: .....134	creme F6461210 Item No.: .....057	beige F6461636 Item No.: .....094	sand F6461230 Item No.: .....058	pistazio F6461610 Item No.: .....153	mint F6461495 Item No.: .....067	aqua F6461456 Item No.: .....001	türkis F6461338 Item No.: .....008
perle F6461288 Item No.: .....007	silber F6461550 Item No.: .....070	stone F6461608 Item No.: .....075	bleu F6461496 Item No.: .....068	dolphin F6461609 Item No.: .....076	sky F6461581 Item No.: .....073	royal F6461196 Item No.: .....051	atoll F6461453 Item No.: .....062
violett F6461356 Item No.: .....059	cyclame F6461381 Item No.: .....119	orchidee F6461354 Item No.: .....011	bordeaux F6461350 Item No.: .....010	kirsche F6461199 Item No.: .....054	feuer F6461454 Item No.: .....063	karneol F6461557 Item No.: .....072	orange F6461556 Item No.: .....071
apricot F6461458 Item No.: .....066	mais F6461457 Item No.: .....065	mango F6461607 Item No.: .....074	safran F6461542 Item No.: .....069	limonade F6461343 Item No.: .....009	limone F6461543 Item No.: .....109	smaragd F6461455 Item No.: .....064	agave F6461273 Item No.: .....006
chrom F6461205 Item No.: .....056	ocean F6461204 Item No.: .....055	schoko F6461357 Item No.: .....060	schwarz F6461195 Item No.: .....050	anthrazit F6461197 Item No.: .....052			

The colors displayed on your device may differ slightly from the original colors. If you wish to receive original color charts, please contact us at [info@ufsk-osys.com](mailto:info@ufsk-osys.com).



# “skai® Pandoria Plus”



skai® Pandoria Plus is a high-quality upholstery material, whose fine micropore structure gives a certain unobtrusiveness, which is refined by an attractive tone-in-tone effect. The very pleasant feel of the material and the excellent material characteristic and the broad, modern color spectrum make skai® Pandoria Plus universally usable.



















## Product Specification

- Long-lasting
- Tear resistant
- Easy to clean
- Abrasion resistant (DIN EN ISO 5470-2)
- Resistant to oil and fat
- Lightfast
- Disinfectant resistant
- Flame protection
- Biocompatibility: cytotoxicity (EN ISO 10 993-5) and epicutaneous test (EN ISO 10 993-10)
- Resistant to sudor, blood and urine
- Antibacterial according to JIS Z 2801
- Vegan

<i>eyeForce</i>		1800 0000
<i>500 XLE</i>		1500 0006
<i>500 XLE comfort</i>		1500 0006
		+ 3037 0080
<i>500 XLS</i>		1500 0005
<i>500 ECO</i>		1500 0008
<i>400 XL</i>		1400 0001
<i>surgiForce</i>	Formed seat	2600 0008
<i>surgiForce light</i>	Formed seat	2600 0009
<i>surgiLine</i>	Formed seat	2200 0008
<i>assistLine</i>		2400 0015
<i>motionLine</i>		1700 0000
<i>motionLine-E</i>		1700 0001

+ Item No.: 3037 0136

+ Item No.: 3037 0...

				
weiß F6413046 Item No.: .....053	hellbeige F6413047 Item No.: .....141	kiesel F6413048 Item No.: .....158	birke F6413049 Item No.: .....159	smoke F6413050 Item No.: .....221
				
silbergrau F6413075 Item No.: .....275	platin F6413053 Item No.: .....161	anthrazit F6413076 Item No.: .....276	schwarz F6413052 Item No.: .....170	schoko F6413051 Item No.: .....160
				
gletscher F6413055 Item No.: .....162	sky F6413074 Item No.: .....277	royal F6413056 Item No.: .....163	smaragd F6413073 Item No.: .....278	kaktus F6413077 Item No.: .....281
				
feuer F6413058 Item No.: .....166	kirsche F6413079 Item No.: .....279	fuchsia F6413078 Item No.: .....280	mais F6413057 Item No.: .....164	limone F6413054 Item No.: .....165

The colors displayed on your device may differ slightly from the original colors. If you wish to receive original color charts, please contact us at [info@ufsk-osys.com](mailto:info@ufsk-osys.com).

# Upgrade your OR to perfection.



*eyeForce*



*500 XLE*



*500 XLE comfort*



*500 XLS*



*500 ECO*



*400 XL*



*motionLine*



*motionLine-E*



*surgiForce*



*surgiForce light*



*surgiTrend*



*surgiLine*



*stayClean wipes*



*stayClean*



*staySoft*



*stayClean roll*



*supportLine*



*supportLine plus*



*assistTrend*



*assistPro F*



*assistPro H*



*easyPro F*



*easyPro H*



*easyPro R*



*easyLine F*



*easyLine R*



*easyLine Rs*



*assistLine*

## CONTACT US



**UFSK**  
INTERNATIONAL

**OSYS**

UFSK-International OSYS GmbH  
Kirchhoffstraße 1  
93055 Regensburg  
Germany

Phone +49 (0) 941 78862 15  
Fax +49 (0) 941 78862 35  
Mail [info@ufsk-osys.com](mailto:info@ufsk-osys.com)  
Web [ufsk-osys.com](http://ufsk-osys.com)

**MADE IN GERMANY**  
Design | Construction | Manufacturing